

# VALEO-E

## CENTRIFUGAL FANS

### Use

- Extract ventilation systems installed in high-rise buildings and premises.
- For buildings with mono-pipe ventilation system.
- For mounting in kitchens and bathrooms.
- Surface wall or ceiling mounting.



**Air flow:**  
up to 102 m<sup>3</sup>/h  
28 l/s



**Power:**  
from 15 W  
**SFP:**  
from 1.04 W/l/s



**Noise level:**  
from 27 dBA



### Design

- The fan consists of the plastic casing for surface mounting and exhaust ventilation unit Valeo with a flat front panel.
- The casing is made of durable ABS plastic and fitted with a gravity back-draft damper to prevent backdrafting.



- The front panel is made of snow-white UV-resistant plastic.
- Filter with filter class G4 for motor, impeller and ductwork system protection against soiling.
- The filter is easily accessible for service operations.
- Due to modern design and various colour modifications the front panel matches well with any interior.
- The casing is equipped with oblong slotted joints to facilitate mounting of the casing in true vertical position.
- Power is supplied to the fan through a sealed electric lead-in on the casing and the ventilation unit is equipped with an airtight terminal block for connection to the wiring system
- Exhaust spigot diameter 80 mm.
- Ingress protection rating IP55.

### Motor

- Two- or three-speed motor with centrifugal impeller. Minimum energy demand.
- Galvanized steel impeller with forward curved blades.
- Automatic maintaining of constant air flow depending on variable air resistance of the duct.
- Balanced impeller ensures low noise operation.
- Best aerodynamic characteristics due to special scroll casing design.
- Ball bearings provide long service life.
- The ventilation unit with motor is fixed inside the casing with special latches.

### Speed control

- Step speed control with an external speed controller, e.g. CDP-3/5 model which is available upon order.
- Wide range of intellectual controls programmable by set parameters (timer, adjustable timer, internal switch, photo sensor, humidity sensor).

#### Designation key

Valeo-E	Hi-Tech Chrome	35/60/100	TR
Model	Panel design	Air flow according to speed	Option

#### Accessories

Filter	Flexible air duct	Speed controller	Clamp
 FP-Valeo	 BlauFlex AN	 CDP-2/5	 K

# VALEO-E

## CENTRIFUGAL FANS

### Options for 2 speed units

o **Timer (Valeo-E...T)**

Depending on wiring connection the fan is off or runs permanently at low speed. The fan is turned to higher speed with external switch 50 s after activation. After turning the switch off the fan continues operating within 6 min at higher speed and then reverts to default operation mode.

o **Adjustable timer (Valeo-E...TR)**

Depending on wiring connection the fan is off or runs permanently at low speed. If the fan is turned on with an external switch it switches to higher speed 0 to 150 s after switch activation. After turning the fan off it continues running at higher speed 2 to 30 minutes and then reverts to previous mode. The fan run-out time and delay time for higher speed are regulated with the internal regulator.

o **Interval switch (Valeo-E...I)**

Depending on wiring connection the fan is off or runs permanently at low speed. In interval mode regulated from 0.5 to 15 hours the fan switches periodically to higher speed for 10 minutes. The switch interval is adjusted with the internal regulator. If light in the room is turned with the external switch the fan switches to higher speed in 50 s. After light is off the fan reverts to interval mode operation.

o **Humidity sensor (Valeo-E...H)**

Depending on wiring connection the fan is off or runs permanently at low speed. The fan switches to higher speed as relative humidity in the room increases from 60 % up to 90 % and switches off as humidity drops by 10 % below set level. If light in the room is turned on the fan switches to higher speed in 50 s. The run-out time is set by the internal regulator from 2 to 30 minutes.

### Mounting

- o Flexible air duct connected to ductwork system and wiring are routed to the fan through wall or ceiling.
- o After finishing works a flexible air duct is fixed on the fan spigot with clamps.
- o Power is supplied to the fan through a sealed electric lead-in on the casing.
- o The casing is installed at site with dowels and is adjusted vertically with oblong slotted joints.
- o The ventilation unit connected to wiring system is installed in the mounted and fixed casing.

### Mounting example

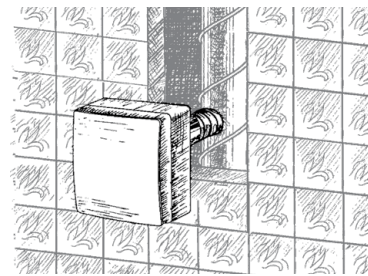

### Front panel modifications

- o The standard snow white front panel can be replaced by the following models:



**Platinum**  
Grey metallic



**Hi-Tech**  
Natural brushed aluminium



**Hi-Tech Gold**  
Natural gold-coloured aluminium



**Hi-Tech Chrome**  
Natural mirror aluminium

### Overall dimensions [mm]

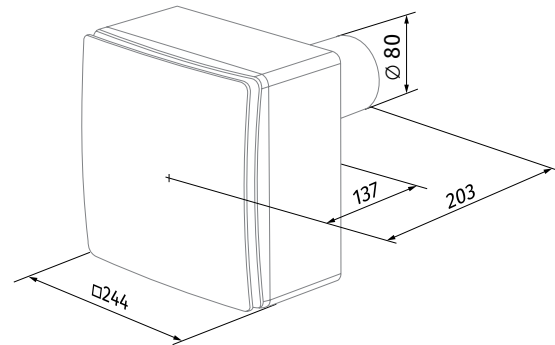

# VALEO-E

## CENTRIFUGAL FANS

### Technical data

Model	Valeo-E 35/60	Valeo-E 35/100	Valeo-E 35/60/100	Valeo-E 60/100	Valeo-E 75/100	Valeo-E 100
Speed	I / II	I / II	I / II / III	I / II	I / II	I
Voltage [V/Hz]	220-240/50	220-240/50	220-240/50	220-240/50	220-240/50	220-240/50
Power [W]	15 / 25	15 / 44	15 / 25 / 44	25 / 44	24 / 29	29
Current [A]	0.12 / 0.14	0.12 / 0.18	0.12 / 0.14 / 0.18	0.14 / 0.18	0.11 / 0.13	0.13
Cable cross section [mm <sup>2</sup> ]	3x1.5	3x1.5	4x1.5	3x1.5	3x1.5	3x1.5
Maximum air flow [m <sup>3</sup> /h (l/s)]	35 (10) / 63 (18)	35 (10) / 102 (28)	35 (10) / 63 (18) / 102 (28)	63 (18) / 102 (28)	75 (21) / 100 (28)	100 (28)
Sound pressure level [dBA]*	27 / 36	27 / 46	27 / 36 / 46	36 / 46	29 / 38	38
Max. transported air temperature [°C]	+50	+50	+50	+50	+50	+50
IP rating	IP55	IP55	IP55	IP55	IP55	IP55

\* Sound pressure level measured in free space at a distance of 3 meters from the fan.

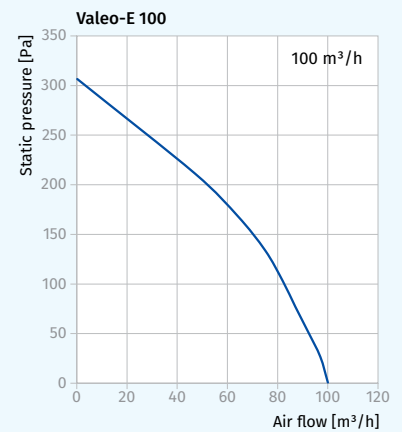
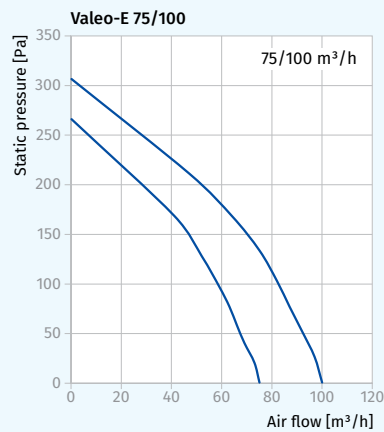
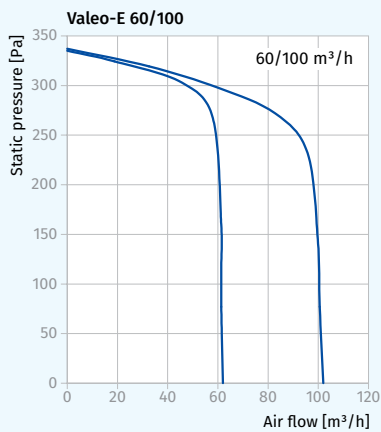
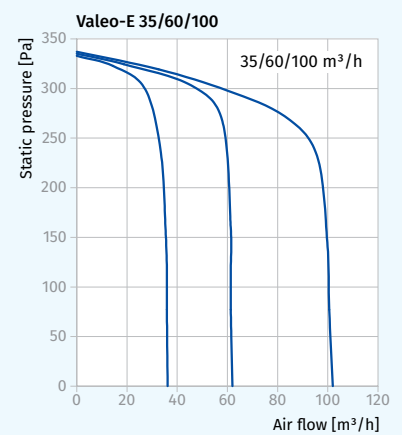
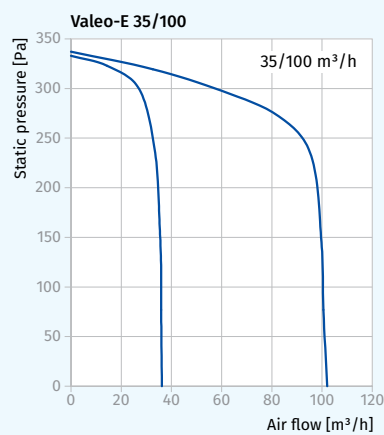
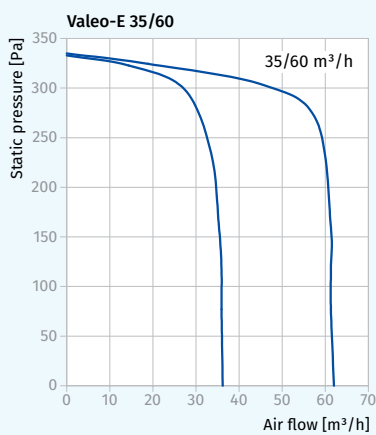

- The abrupt curves show high pressure performance and constant air flow of several **Valeo-E** fans integrated into a single ventilation shaft.

# VALEO-E

## CENTRIFUGAL FANS

### High-rise mono-pipe ventilation system arrangement example

- The mechanical centralized mono-pipe exhaust ventilation system for kitchens and bathrooms based on **Valeo-E** fans is specially designed for high-rise residential premises.
- Fresh air is supplied to bedrooms, children's room or living rooms through window or wall vents. Vent modifications with air volume regulation are available.

- Stale air is extracted by exhaust fans from the room through inside doors or door grilles in the kitchen, bathroom or WC.
- This ventilation system arrangement ensures non-stop controllable air circulation in the room, comfortable microclimate and high fire safety.

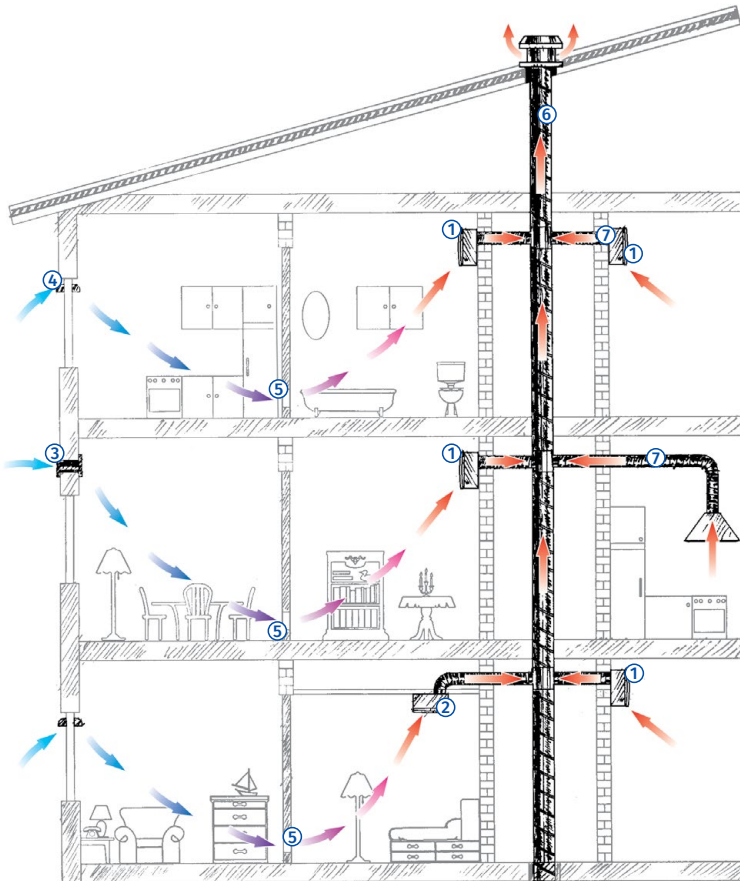

- 1 - Exhaust fan **Valeo-E** (surface mounting).
- 2 - Exhaust fan **Valeo-E** (ceiling mounting).
- 3 - BLAUBERG wall vent, **WMH** series.
- 4 - BLAUBERG window vent, **FHM** series.
- 5 - BLAUBERG ventilation grilles, **DECOR** series.
- 6 - Central ventilation shaft.
- 7 - Flexible air ducts for connection of exhaust fans to the central ventilation shaft, e.g. BLAUBERG air ducts, **Blauflex** series.